

LIPARI

Family of recessed indoor downlights for accent lighting.

The luminaire/fixture is rotatable by 30° vertically and 355° horizontally to allow the free orientation of the light in any direction.

The modular structure separates the lamp into several independent parts.

The outer rings with different finishes are simple to assemble and can be replaced easily to meet different opening requirements and appearance effects.

A variety of optical accessories are available to achieve different lighting effects.



RECESSED TRIMLESS 15° | 2700K

LAMPING

Source	LED spot
Total power	28W
Emission	Direct adjustable 15°
Switching	according to driver
Tension	IN 36V-600mA
Color temperature	2700K
Luminous flux	1400lm
Typ CRI	> 90
Energy class	F
IP class	20
Dimensions	ø12,2x15,5cm
Notes	driver and ring not included
Accessories	Drivers, Lipari Lipari ring, Lipari ring
Net lamp weight	0,92 kg

Codes

LIP LW2 61

Structure

white

PACKAGE

Package 01

Dimension: 46x45,5x35,8 cm / Gross weight: 1,3 kg

Certificazioni



TRIMLESS

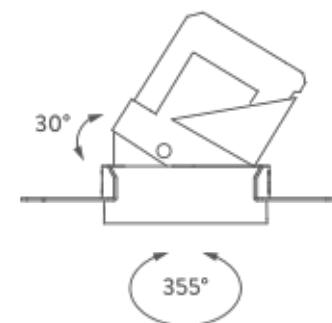
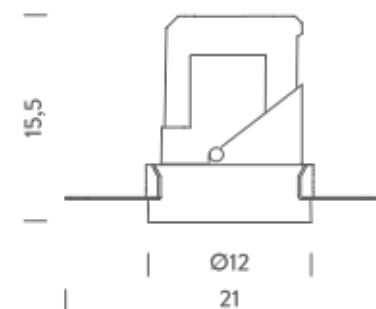

TRIM

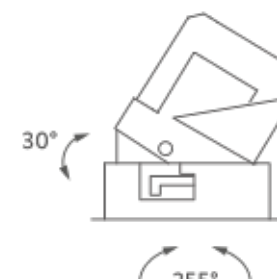
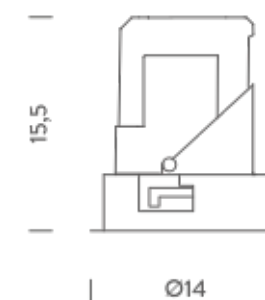

RECESSED TRIMLESS 15° | 3000K

LAMPING

Source	LED spot
Total power	28W
Emission	Direct adjustable 15°
Switching	according to driver
Tension	IN 36V-600mA
Color temperature	3000K
Luminous flux	1400lm
Typ CRI	> 90
Energy class	F
IP class	20
Dimensions	ø12,2x15,5cm
Notes	driver and ring not included
Accessories	Drivers, Lipari Lipari ring, Lipari ring
Net lamp weight	0,92 kg

Codes

LIP LW3 61

Structure

white

PACKAGE

Package 01

Dimension: 46x45,5x35,8 cm / Gross weight: 1,3 kg

Certificazioni



TRIMLESS

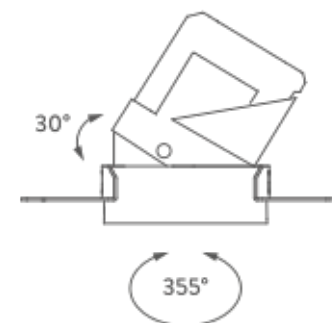
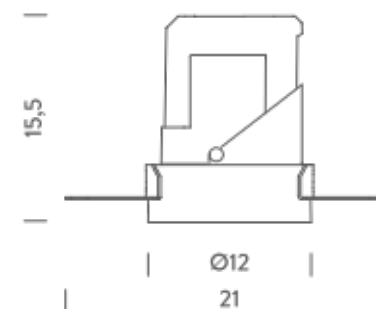

TRIM

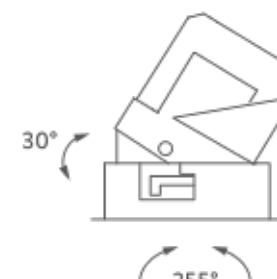
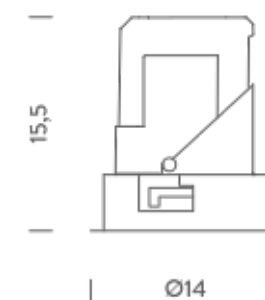

RECESSED TRIMLESS 35° | 2700K

LAMPING

Source	LED spot
Total power	28W
Emission	Direct adjustable 35°
Switching	according to driver
Tension	IN 36V-600mA
Color temperature	2700K
Luminous flux	1400lm
Typ CRI	> 90
Energy class	F
IP class	20
Dimensions	ø12,2x15,5cm
Notes	driver and ring not included
Accessories	Drivers, Lipari Lipari ring, Lipari ring
Net lamp weight	0,92 kg

Codes

LIP LW2 63

Structure

white

PACKAGE

Package 01

Dimension: 46x45,5x35,8 cm / Gross weight: 1,3 kg

Certificazioni



TRIMLESS

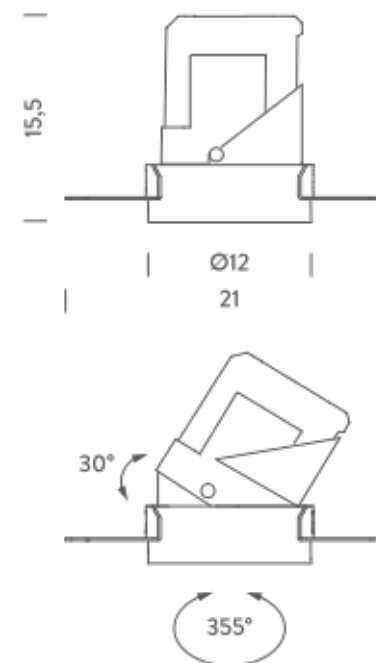

TRIM

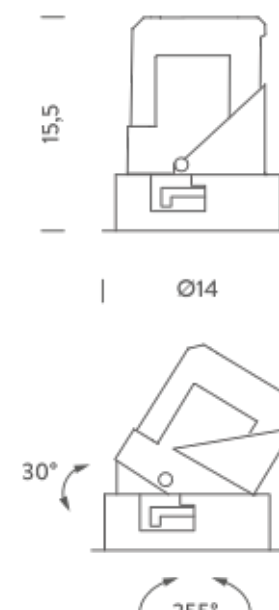

RECESSED TRIMLESS 35° | 3000K

LAMPING

Source	LED spot
Total power	28W
Emission	Direct adjustable 35°
Switching	according to driver
Tension	IN 36V-600mA
Color temperature	3000K
Luminous flux	1400lm
Typ CRI	> 90
Energy class	F
IP class	20
Dimensions	ø12,2x15,5cm
Notes	driver and ring not included
Accessories	Drivers, Lipari Lipari ring, Lipari ring
Net lamp weight	0,92 kg

Codes

LIP LW3 63

Structure

white

PACKAGE

Package 01

Dimension: 46x45,5x35,8 cm / Gross weight: 1,3 kg

Certificazioni



TRIMLESS

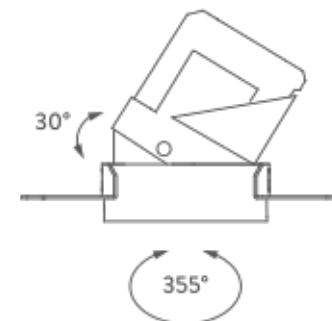
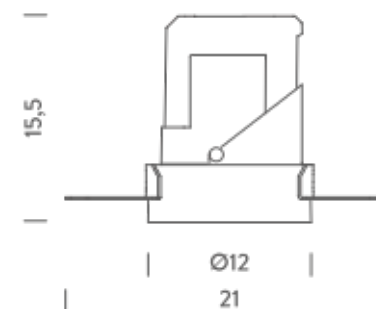

TRIM

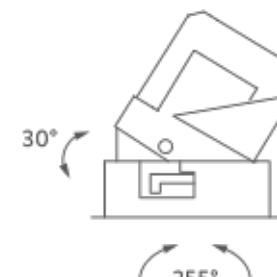
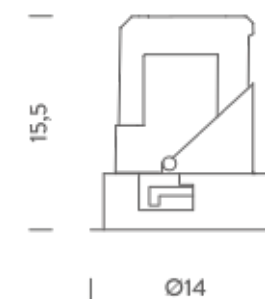

RECESSED TRIM 15° | 2700K

LAMPING

Source	LED spot
Total power	28W
Emission	Direct adjustable 15°
Switching	according to driver
Tension	IN 36V-600mA
Color temperature	2700K
Luminous flux	1400lm
Typ CRI	> 90
Energy class	F
IP class	20
Dimensions	ø13,8x15,5cm
Notes	driver and ring not included
Accessories	Lipari ring, Lipari ring
Net lamp weight	0,88 kg

Codes

LIT LW2 61
LIT LN2 61

Structure

white
black

PACKAGE

Package 01

Dimension: 46x45,5x35,8 cm / Gross weight: 1,25 kg

Certificazioni



TRIMLESS

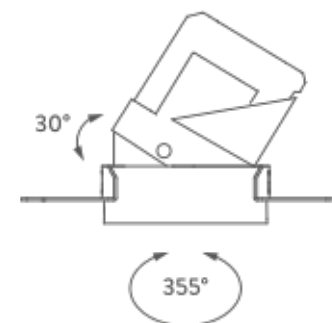
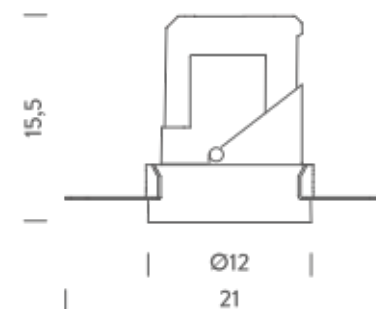

TRIM

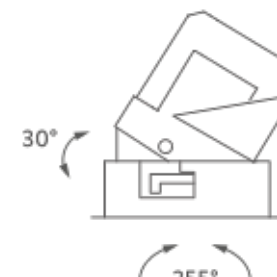
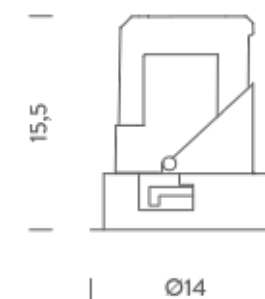

RECESSED TRIM 15° | 3000K

LAMPING

Source	LED spot
Total power	28W
Emission	Direct adjustable 15°
Switching	according to driver
Tension	IN 36V-600mA
Color temperature	3000K
Luminous flux	1400lm
Typ CRI	> 90
Energy class	F
IP class	20
Dimensions	ø13,8x15,5cm
Notes	driver and ring not included
Accessories	Lipari ring, Lipari ring
Net lamp weight	0,88 kg

Codes

LIT LW3 61
LIT LN3 61

Structure

white
black

PACKAGE

Package 01

Dimension: 46x45,5x35,8 cm / Gross weight: 1,25 kg

Certificazioni



TRIMLESS

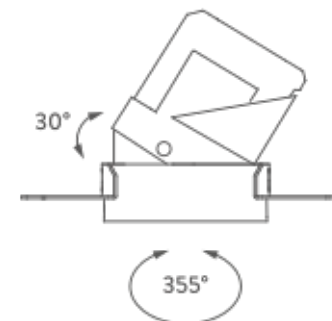
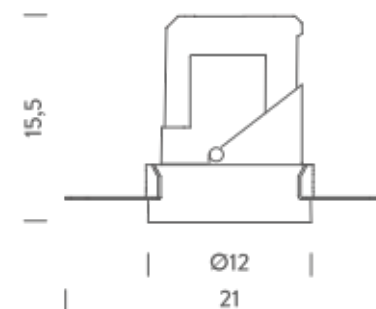

TRIM

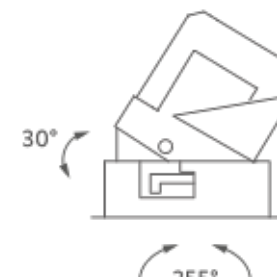
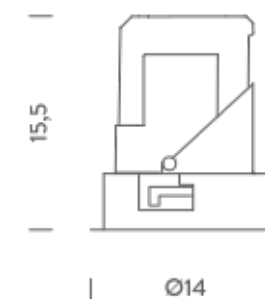

RECESSED TRIM 35° | 2700K

LAMPING

Source	LED spot
Total power	28W
Emission	Direct adjustable 35°
Switching	according to driver
Tension	IN 36V-600mA
Color temperature	2700K
Luminous flux	1400lm
Typ CRI	> 90
Energy class	F
IP class	20
Dimensions	ø13,8x15,5cm
Notes	driver and ring not included
Accessories	Lipari ring, Lipari ring
Net lamp weight	0,88 kg

Codes

LIT LW2 63
LIT LN2 63

Structure

white
black

PACKAGE

Package 01

Dimension: 46x45,5x35,8 cm / Gross weight: 1,25 kg

Certificazioni



TRIMLESS

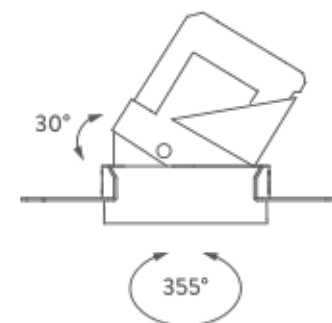
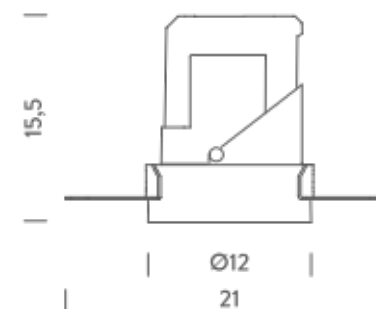

TRIM

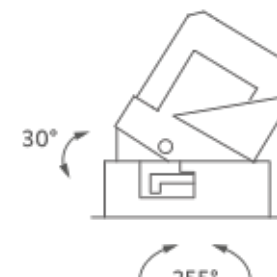
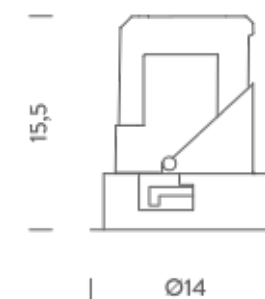

RECESSED TRIM 35° | 3000K

LAMPING

Source	LED spot
Total power	28W
Emission	Direct adjustable 35°
Switching	according to driver
Tension	IN 36V-600mA
Color temperature	3000K
Luminous flux	1400lm
Typ CRI	> 90
Energy class	F
IP class	20
Dimensions	ø13,8x15,5cm
Notes	driver and ring not included
Accessories	Lipari ring, Lipari ring
Net lamp weight	0,88 kg

Codes

LIT LW3 63
LIT LN3 63

Structure

white
black

PACKAGE

Package 01

Dimension: 46x45,5x35,8 cm / Gross weight: 1,25 kg

Certificazioni



TRIMLESS

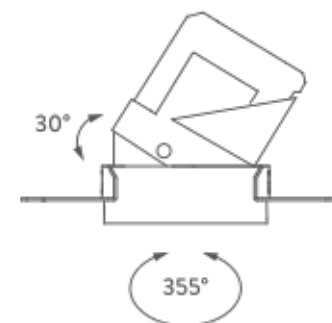
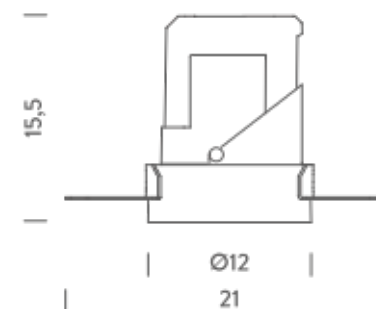

TRIM

